

VIEWPROOF User Guide

Introduction

VIEWPROOF is a single-channel DVR specially designed for covert surveillance. With no disks, fans or any moving parts, the unit is extremely compact, totally silent and easy to conceal. Integrated video motion detection and variable recording schedules allow optimisation of recording capacity. The surveillance video is recorded onto Compact Flash Cards.

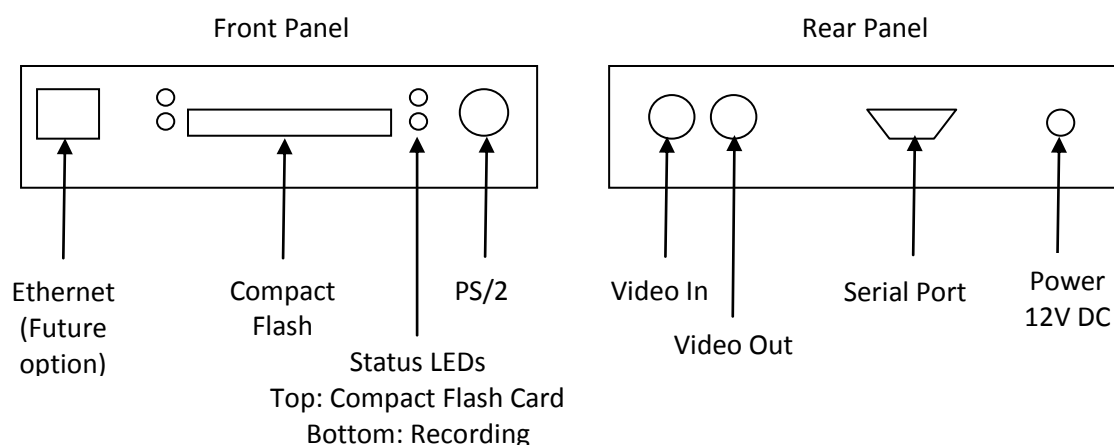

Setting Up

Before you start using VIEWPROOF, you need to configure it to operate as required. You will need:

- PC
- Compact Flash Card Reader
- VIEWPROOF Configuration Software
- Compact Flash Cards
- VIEWPROOF module
- VIEWPROOF Power Supply

Installing the VIEWPROOF Configuration Software

1. Insert the CD provided with VIEWPROOF into the PC CD drive.
2. Follow the on screen instructions to install the Configuration software.
3. When you have completed the installation, an icon will appear on your desktop.

Setting the Time

Note: The time on VIEWPROOF will not automatically change with day light saving time.

1. Connect VIEWPROOF to the power source.
2. Connect VIEWPROOF to your PC using the RS232 serial port.
3. On your PC run HyperTerminal (Start->All Programs->Accessories->Communications->HyperTerminal).
4. Enter a name for the connection, e.g. 'VIEWPROOF'.
5. For the 'Connect using' option select the COM port being used, e.g. COM1.

6. Use the following for the Port Settings (Bits per second=115200, Data bits=8, Parity=None, Stop bits=1, Flow control=None).
7. Type 'date' and press enter to display the current time and date of the unit.
8. The command format for setting the date and time is 'date day month year hour minute second'. The month is specified as a number between 1 and 12, the year is specified without the leading '20' and the hour is specified in 24 hour format. As an example, to set the time and date to 2:15:34pm on 23rd April 2008 you would type 'date 23 4 8 14 15 34'.
9. Close the HyperTerminal window.

Formatting of compact flash card

Before you can start recording video images using VIEWPROOF, you will need to format the compact flash card. The formatting is an automatic process when the card is inserted.

1. Connect VIEWPROOF to the power source using the power supply provided
The top red LED will be on to indicate that there is no card present.
2. Insert the compact flash card into the card slot
The top red LED will flash indicating that the card is being formatted.
3. When the top red LED goes off, the card has been successfully formatted and is ready for use.

Configuring the operation of VIEWPROOF

Before using VIEWPROOF, you will need to configure it to operate in your required method. There are two methods of operation that you can select:

- To start recording at a predefined time and then to stop at a later predefined time.
- To start recording with an alarm trigger

1. Connect your Compact Flash Card Reader to the PC following the manufacturer's instructions.
2. Insert the Compact Flash Card into the PC card reader
3. Start the VIEWPROOF Configuration Software

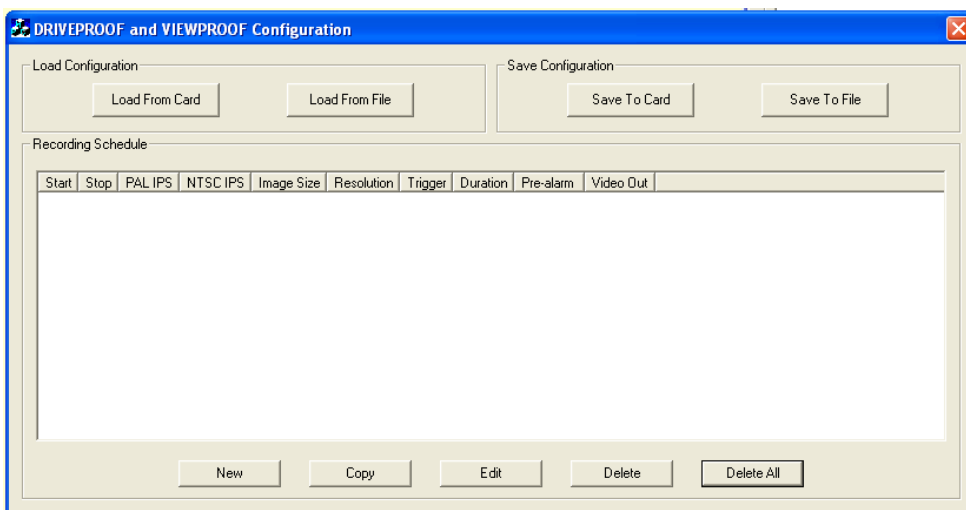

4. Select New to create a recording schedule

Start	Select the day to start recording and enter the time to start recording. For use with an event trigger only, set the start time to 00:00:00 and to any day.
Stop	Select the day to stop recording and enter the time to stop recording. For use with an event trigger only, set the start time to 00:00:00 and to the same day as the Start.
Images Per Second	Use the slider bar to set the required images per second to be used for recording: PAL range 25 – 0.1, NTSC 32 – 0.1
Image Size	Use the slider bar to set the required image size 10KB to 32KB. Unless you are using a very high quality camera, you may not see much difference in image quality with the higher resolution settings. Nor will the image size setting affect the size of the exported files, as they are all exported at the resolution defined by the exporting CODEC. To change that you will need to alter the settings of the CODEC that you are using. The image size option in the configuration affects the image quality of the images stored on the card (and therefore the duration of video that can be stored on the card). When exporting video from the viewer application, each image is fully decompressed before having text overlaid and then re-compressed by the CODEC.
Image Mode	Select either Frame or Field
Trigger	Select Continuous to record between the start and stop times Select from Alarm 1 or Alarm 2 Edge NO Triggers at the point when the contacts close. Edge NC Triggers at the point when the contacts open. Level NO Triggers when the contacts are closed and remains triggered until they open. Level NC Triggers when the contacts are open and remains

VIEWPROOF User Guide

	<p>triggered until they close.</p> <p>Duration determines how many seconds recording will continue for after an alarm is no longer triggered.</p> <p>Pre-alarm determines how many seconds prior to the alarm being activated the recording will start.</p>
Miscellaneous	Select to enable the video out port that will allow monitoring of the recorded video from the VIEWPROOF.

5. Select OK to close the configuration, the file will appear in the Recording Schedule. This process can be repeated to create several schedules to be included in the configuration file.
6. Save the file to either the Compact Flash Card or disk for use on future cards

Changing a configuration

Once you have created a configuration file, you can make changes as required.

1. Start the VIEWPROOF Configuration Software
2. Select Load From Card or Load From File to list a configuration file
3. Highlight the schedule to be modified and select Edit
4. Change the schedule as required and select OK
5. The updated schedule will appear in the Recording Schedule.
6. Save the file to either the Compact Flash Card or disk for use on future cards

Creating a new configuration

Once you have created a configuration file, you can use this file as a base to create other files.

1. Start the VIEWPROOF Configuration Software
2. Select Load From Card or Load From File to list a configuration file
3. Highlight the schedule to be modified and select Copy
4. Change the schedule as required and select OK
5. The new schedule will appear in the Recording Schedule
6. Save the file to either the Compact Flash Card or disk for use on future cards

Installation

The VIEWPROOF unit needs to be mounted securely within the vehicle. We recommend that the unit is installed in a lockable box or in a covered area with locking screws to prevent unauthorised access to the unit.

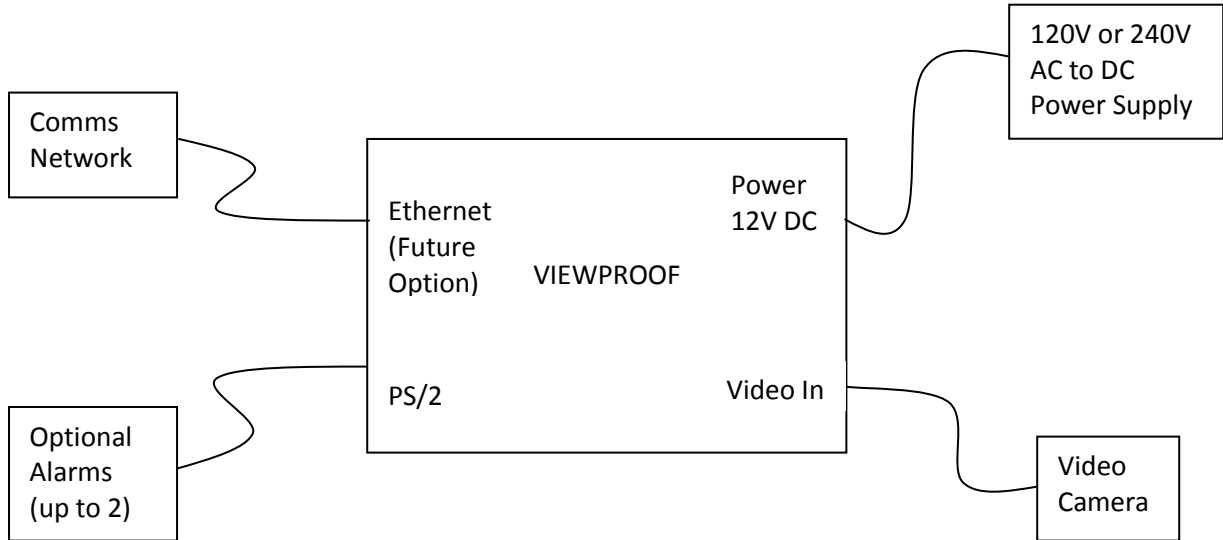

Video Camera

VIEWPROOF will support a video camera that provides an output to a composite video 1Vpp, BNC connection.

Power Supply

VIEWPROOF requires the power supply to provide a 12DC output from the building power source.

Alarm Connection

The alarm requires a single signal from a sensor to indicate to VIEWPROOF that it has been triggered. It is connected via the PS/2 connector on the front panel. The following diagram shows the required pin out of the PS/2 connector.

Pin 1 Alarm 2

Pin 3 Ground

Pin 5 Alarm 1

Each alarm is either open or closed (connected ground). The configuration software is used to select the type of alarm trigger and its duration.

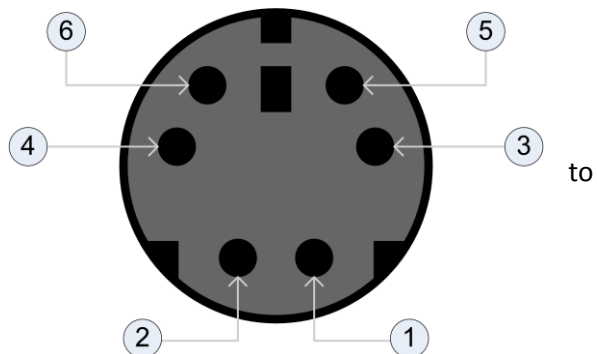

Ethernet Connection

A future option

Playback

Using VIEWPROOF PC Viewer

To view the video recorded, you will need to have a PC with the VIEWPROOF playback software installed and a suitable Compact Flash Card Reader connected to the PC.

Installing the VIEWPROOF Playback Software



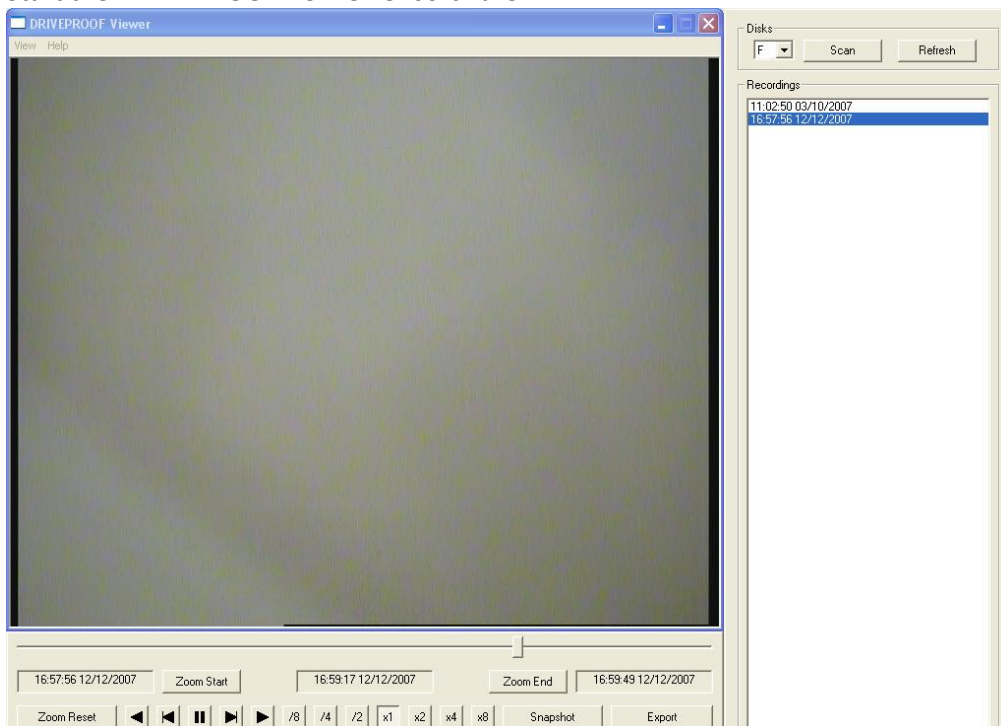

1. Insert the CD provided with VIEWPROOF into the PC CD drive.
2. Follow the on screen instructions to install the Playback software.
3. When you have completed the installation, an icon will appear on your desktop.

Playing Back Video Recordings







1. Connect your Compact Flash Card Reader to the PC following the manufacturer's instructions.
2. Insert the Compact Flash Card into the PC card reader
3. Start the DRIVE PROOF PC Viewer software



4. Select the Refresh button to detect the card reader
5. Select the dropdown arrow to select the drive letter for the card reader. The list of recordings on the card will be displayed.
6. Select the Scan button to display a list of the recordings on the card
7. Select the recording to be viewed. The still image from the first frame will appear in the video window.
8. You can now use the playback controls under the video window to view the recording

Control	Description
	Start playing in forward direction
	Step through recording frame by frame in forward direction
	Start playing in reverse direction
	Step through recording frame by frame in reverse direction
	Pause the playback
/n	Decrease playing speed by 2, 4 or 8
xn	Increase playing speed by 2, 4 or 8
x1	Normal playing speed
Zoom Start	Selecting the start time of the recording to view in detail. The left hand side of the slider moves to the start time selected.
Zoom End	Selecting the end time of the recording to view in detail. The right hand side of the slider is set to the end time selected.
Zoom Reset	Resets the start and end times to the beginning and end of the full recording.
Snapshot	Selects the current image to be saved as a bitmap file.
Export	Export the current zoom range to an AVI file.

Pausing playback/ slow or fast motion play

1. During playback, select  to pause playback and display a still picture
2. To move the still picture one frame backward or forward, select  or  keys repeatedly.
3. To start a slow motion playback, select the speed /8, /4, /2 and then select  or  to play forward or backward.
4. To start a fast motion playback, select the speed x8, x4, x2 and then select  or  to play forward or backward.

Selecting a section to store

1. During playback, pause the playback.
2. To set the start point, select the *Zoom Start* button. The start time will appear in the box to the left of the *Zoom Start* button.
3. To set the end point, during playback, select the *Zoom End* button to stop the playback. The end time will appear in the box to the right of the *Zoom End* button.
4. To playback the selection, drag the slider back to the left hand side and select  to play the selection forwards.

Saving to disk

The video CODEC used for exporting the video recording must support compression and decompression. Most of the CODECs installed with Windows only support decompression. Only the CODECs that support compression will be listed in the Viewer. If there are none listed, you will need to install a CODEC that supports compression. For example, Xvid (<http://www.xvid.org>) is free to download and is compatible with the Viewer.

1. Use the *Zoom Start* and *Zoom End* controls to mark the selection to be saved.
2. Select the *Export* button
3. Choose the video compressor and the compression quality

Technical Specifications

Video Input	Composite video 1Vpp, BNC connection
Video Output	Composite video 1Vpp, BNC connection for Live/Playback
Resolution	NTSC : 720 x 480 PAL: 720 x 576 (4CIF)
Record Rate	NTSC : adjustable 0.1 to 30 fps PAL: adjustable 0.1 to 25 fps
Image Compression	JPEG 2000 Minimum frame file size : 2KB Maximum frame file size : 32KB
Archiving /Data Transport	High speed Compact Flash Card (at least 40x)
Network Connection	1Mb/s Ethernet (future option)
Recording Media	1GB, 2GB, 4GB, 8GB or 16GB Compact Flash card
Recording	Continuous with event marking (via external alarm input)
Alarm Inputs	1
Keyboard Port	Standard PS/2
Playback Control	Play, pause, fast-forward, fast rewind, jump 1 minute, jump 5 minutes, jump to next/previous event, all via a standard PS2 PC keyboard
Communication Port	RS232 Serial Link connects to PC for configuration, if required
Power	External Power Supply 12 to 24V DC power supply
Power consumption	7W
Cooling	Fanless System
Dimensions	W : 110mm x D : 170mm x H : 33mm
Environmental	Operating : 5 deg F to 125 deg F (-15 deg C to 50 deg C)
Approvals	CE, FCC, RoHS